

- (A) Colector drenaje 2"
2" Drainage manifold
- (B) Colector entrada 10"
10" Inlet manifold
- (C) Colector salida 10"
10" Outlet manifold

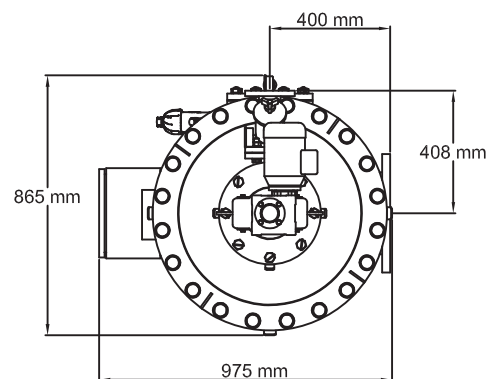

AZUD LUXON LDB 21300 S/10

SCALE S/E A4 FORMAT	MATERIAL:	RESPONS.: M. Martínez	AZUD
	UNITS: mm.	REVISION: 00	
	FILE: Azud_luxon_LDB_21300-S10.dwg	08/05/2012	