

- (A) Colector drenaje 1"  
**1" Drainage manifold**
- (B) Colector entrada 2"  
**2" Inlet manifold**
- (C) Colector salida 2"  
**2" Outlet manifold**

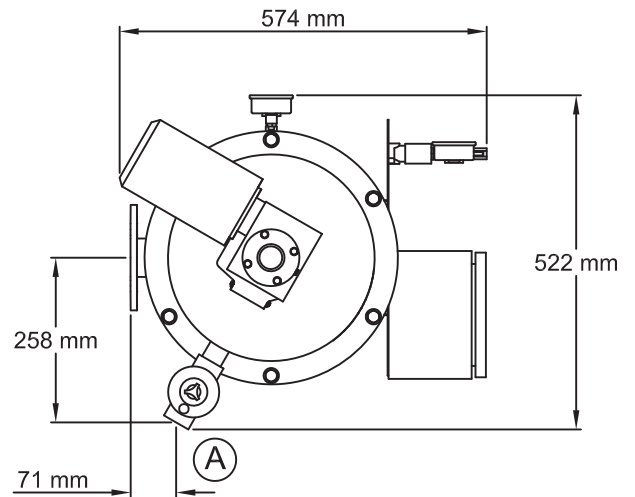

### AZUD LUXON LDB 900/2

SCALE S/E A4 FORMAT	MATERIAL:	RESPONS.: M. Martínez	<b>AZUD</b>
	UNITS: mm.	REVISION: 00	
	FILE: Azud_luxon_LDB_900-2.dwg	31/05/2011	